



## SP9100 8 Switch Programmable Switch Panel Power System

### KEY INSTALLATION POINTS

**Failure to follow installation instructions may affect warranty coverage.**

1. **Do not modify the communications cable, which connects the switch panel and power module.**
  - Why? The SP9100 uses specialty communication protocol that can be interrupted and malfunction if the cable is altered in any way. For a different length, please visit our webstore.
2. **The Light-Blue Ignition wire needs to be tapped into a 12V source.**
  - Why? When the Light-Blue Ignition wire senses 12V, the panel backlighting illuminates, and IGN programmed switches are operational. To override the need for the IGN wire, program switches to be Battery Input.
3. **Connect the Black Ground wire directly to the negative terminal of the battery.**
  - Why? The battery drains out the most electrical noise, reducing the risk for interference with our communication protocol.
4. **Do not connect any other power feeds to the stud on the power module.**
  - Why? The power module is not designed to support other equipment, beyond those that are powered by the output wires.
5. **Mount the power module in a vertical position, with the connectors facing outward, not upward.**
  - Why? This allows water to run off, and not collect on the top of the connector, or face of the module. Pooling water can cause corrosion over time.

### GET TO KNOW THE PARTS

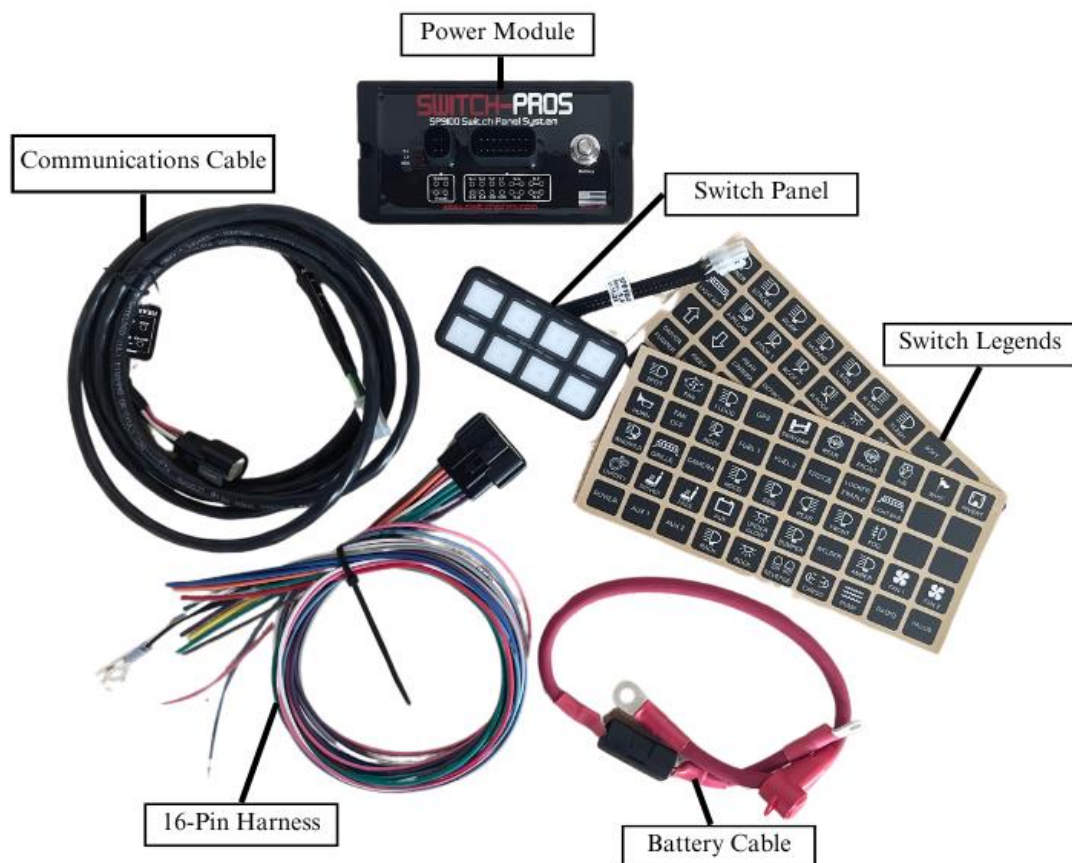

## SP9100 SPECIFICATIONS

<p><b>Power Module:</b>          Size: 6.0" x 3.0" x 0.6"          Height with Connectors: 1.48"          Height with Connectors Plugged in and Wires: 2.8"          Enclosure Material: Anodized Aluminum          Temperature Rating: Automotive -40°C to 125°C          Water and Dust Proof Rating: IP67          Amperage Rating: 125A max          Switch 1 – 4 Outputs: 20A max          Switch 5 – 8 Outputs: 35A max          Current Draw: 35mA          Current Draw at Idle (1 min No Activity): 5.5mA          Current Draw in Sleep Mode (8 hrs No Activity): 3mA          Inputs Voltage Threshold - Active HIGH: &gt; 4.5V          Inputs Voltage Threshold - Active LOW: &lt; 0.5V</p>	<p><b>Switch Panel:</b>          Size: 4.0" x 2.0" x 0.365"          Enclosure Material: Anodized Aluminum          Switch Panel Overlay and Legends Material: Polycarbonate          Temperature Rating: -30°C to 85°C          Water and Dust Proof Rating: IP67          Backlighting Color: RGB          Switch LED Indicator Color: Amber          Bluetooth: BLE 4.1 Apple and Android</p>
--	--

## INSTALLATION

### 1. Switch Panel

#### 1.1. Mounting Options

- Surface Mount: Drill 4 holes for the 6-32 mounting studs and a 5/8 (0.625") hole for the harness and connect to feed through. Then, screw the threaded studs into the switch panel enclosure, and secure the with the 6-32 nuts.
- Recessed Mount: Cut a rectangular opening measuring 3.875" x 1.875" with a corner radius of 0.237". Then, screw the four 6-32 threaded studs into the backside of the switch panel and tighten. Place the switch panel into the opening and slide the two mounting brackets over the studs. Secure the mounting brackets with the 6-32 nuts.
- Note: The diagram to the right can be cut out and used as a template. Inside of black perimeter line (white area) should measure 3.875" x 1.875" with a 0.237" corner radius.
- Note: It is critical that the switch panel be securely mounted as to not cause strain on the wires on the back or allow rubbing against anything that could cut the wires.
- Note: Do not pressure wash the switch panel as water intrusion will cause corrosion and, therefore, malfunctioning.

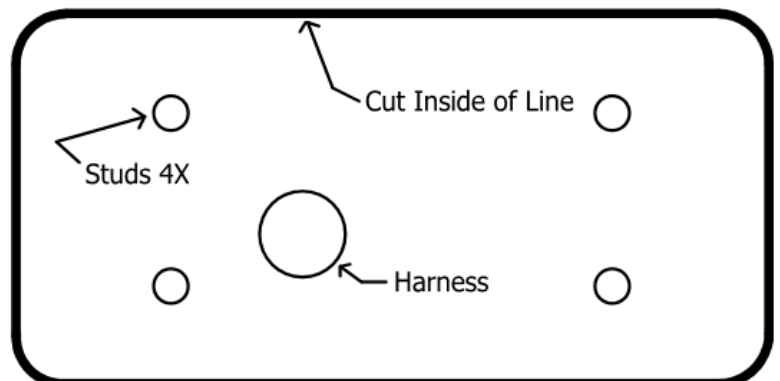

## 2. Power Module

### 2.1 Mounting Guidelines

- Mount within 2' of the vehicle's battery, as that is the standard length of the Battery Cable.
- Mount in a vertical position, with the connectors facing outward, rather than upward, so water cannot accumulate on the connector seals.
- Recommended mounting locations include: on the firewall near the fender, or on the fender.
  - The Power Module is manufactured with automotive rated electronic parts, with a temperature rating of -40°C to 125°C.
  - Note: Do not mount the power module in a location near the engine exhaust, where temperatures will exceed the rating.
  - Note: The App will display the temperature of the Power Module, so it can be monitored.



- Note: The Communications Cable that connects the Switch Panel and Power Module will be the last connection made.

## 3. 16-Pin Output Harness

### 3.1 Output Wires

- Switches 1 - 4 have a single, 14 AWG, wire, and are rated at a maximum of 20 Amps.
- Switches 5 - 8 each have 2, 14 AWG, wires, and are rated at a maximum of 35 Amps.
  - Note: BOTH wires must be tied together to create a 35A circuit.
  - Note: The wires may be split, to power separate accessories, at a maximum of 17A for each wire, but both accessories will come on and off together, since they are the same Switch.
- The output wires are 14 AWG.
  - Note: 14 AWG wire is sufficient for a load up to 20A, with a run no longer than 6 feet. For longer runs at max current, it is recommended to use a smaller gauge wire, such as 12 or 10 AWG.
  - Note: To figure out the current draw of an accessory rated in Watts, simply divide power rating of the accessory by the operating voltage. For example, a 300W light bar, running at 12V:  $300W/12V = 25 A$ .
- Connect the 14 AWG output wires to the positive lead of the accessory. Connect the Ground wire of the accessory to a Ground stud on the vehicle's frame, or the negative terminal of the battery.
- The output wires switch a 12V signal. They will not switch a Ground signal.
- Current limits for the Switches can be adjusted, in the App, in 5A increments. We recommend setting the overcurrent protection 15 - 20% higher than the maximum current draw of the accessory.

- Note: Do not set current limits too low. When battery voltage decreases, amperage draw increases.

### 3.2 Black Ground Wire

- The Black Ground Wire is a single, 18 AWG wire, with a blue lug crimped on the end.
- The Black Ground Wire should be connected directly to the negative terminal of the battery.
  - Note: It is acceptable to shorten or lengthen this wire, depending on distance between the Power Module and Battery.

### 3.3 Input Wires

- Light Blue Ignition Wire – When this wire senses voltage, ignition programmed switches become operational, and the Switch Panel backlighting illuminates.
  - Tap this wire into an ignition or accessory switched, 12V source, using an Add-a-Circuit, fuse tap, or similar apparatus.
    - Note: Typically, fuses in the fuse box, labeled IGN or ACC, are correct places to tap this wire in. The right source has 12V when the key is in ignition or accessory mode and ceases to have 12V when the key is in the off position.
    - Note: The supplied Add-a-Circuit will come with a low amperage fuse. Insert the supplied fuse into the slot furthest from the prongs. Use the fuse, from the fuse box slot where the Add-a-Circuit will be inserted, to fill the slot closest to the prongs. Then, insert the Add-a-Circuit into fuse slot, from which you removed the factory fuse, and crimp the input wire to the blue butt splice.

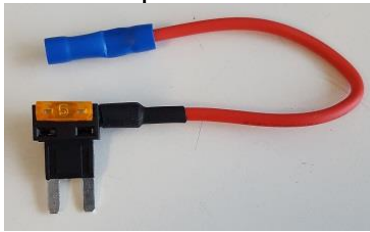

Add-a-Circuit

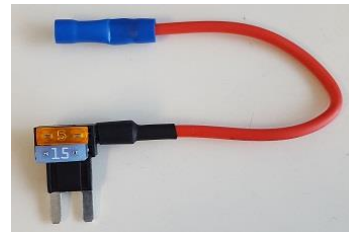

Add-a-Circuit with fuse inserted

- Note: If the backlighting is always illuminated, even with the vehicle's ignition off, the wire is tapped into an incorrect fuse.
- Note: When the Light Blue Ignition Wire senses 12V, the red LED indicator, labeled IGN, on the Power Module, will illuminate.
- Note: If you want certain switches to always be operational, whether the key is on or off, program those individual switches to be "Battery" in the App Settings (See Section 7.1).
- Note: A Bluetooth connection overrides the Ignition input. All Ignition programmed switches will operate if the Ignition is off, but a Bluetooth connection is present. This allows the operator to remotely control accessories, without being required to leave the ignition on.
- White Lights/T2 Wire – When this wire senses 12V, it dims the Switch Panel backlighting, just as dash lights dim at night. The backlight and LED indicator intensity, when the White Lights/T2 Wire is sensing 12V, is adjustable through the LED Backlight App Settings (See Section 7.2).
  - Tap this wire into a parking light, side marker light, or other source that you want the Switch Panel backlighting to dim with.



Place wire in t-tap

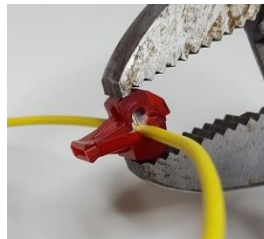

Crimp

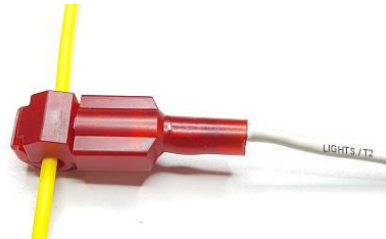

Plug in blade connector

- Note: This feature is optional. It is not required to be wired up for operation.

- Note: The Switch Panel backlighting is only adjustable when the White Lights/T2 Wire is sensing 12V.
- Note: If the Switch Panel backlighting remains illuminated after the key is in the off position, the White Lights/T2 Wire may still be sensing 12V.
- Note: When the White Lights/T2 Wire senses 12V, the red LED indicator, labeled LT, on the Power Module, will illuminate.
- Pink Trigger 1 Wire – This wire allows an external source to trigger multiple Switch-Pros outputs.
  - Tap this wire into an external trigger, such as a high beam signal, reverse light signal, dome light signal, temperature gauge, etc.
    - Note: This feature is optional. It is not required to be wired up for operation.
  - Up to 4 outputs can be programmed to come on with the trigger.
    - Note: Outputs programmed to be turned on with the External Trigger can still be turned on and off through the Switch Panel.
    - Note: This wire can sense a 12V (Active High) or Ground (Active Low) signal. The trigger activation method can be changed in the External Trigger App Settings (See Section 7.8).

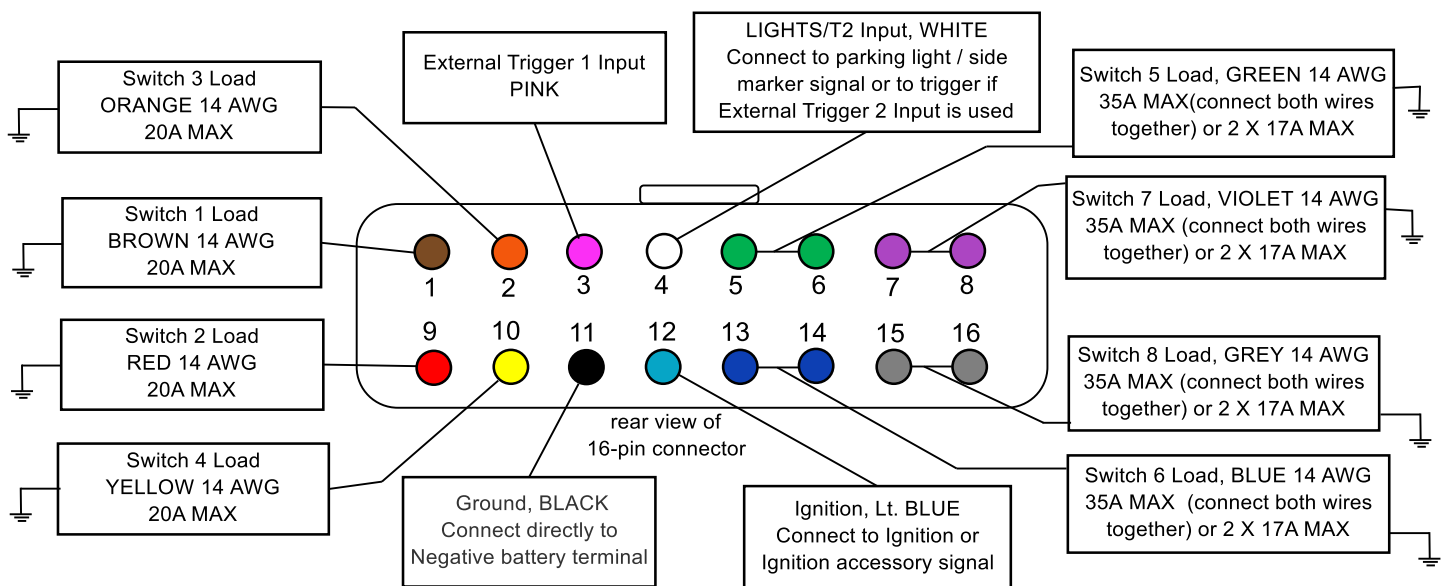

## 4. Battery Cable

4.1 The Battery Cable is a 2.5', 4 AWG welding cable, with a 125A in-line fuse, that connects to the stud on the Power Module and the positive terminal of the battery.

- The Battery Cable may be installed, once the Power Module and Switch Panel are mounted, the 16-Pin Output Harness is plugged in, and the Black Ground Wire is connected directly to the negative terminal of the battery. The Communications Cable should not be plugged in yet.
- Note: Before connecting the Battery Cable to power, be sure the Light Blue Ignition Wire is not sensing voltage.
  - If the Light Blue Ignition Wire senses voltage before the Battery Cable is connected, the Switch Panel Bluetooth will temporarily lock up, and the Programming Light, in the top, center, of the Switch Panel, will be illuminated blue. To unlock the Bluetooth, unplug the Communications Cable, either from the back of the Switch Panel or the Power Module, for 30 seconds. When the Communications Cable is plugged back in, the Bluetooth capability will be available again and the Programming Light will no longer be illuminated.
- Connect the longer section of the Battery Cable to the Power Module first, then connect the shorter side, with the fuse holder, directly to the positive terminal of the battery.
  - Note: Do not connect any other power feeds to the Power Module stud.
  - Note: The system is only compatible with a 12V battery.
- Use a 9/16" socket to tighten the nut onto the Power Module stud.

### Battery Cable Connection

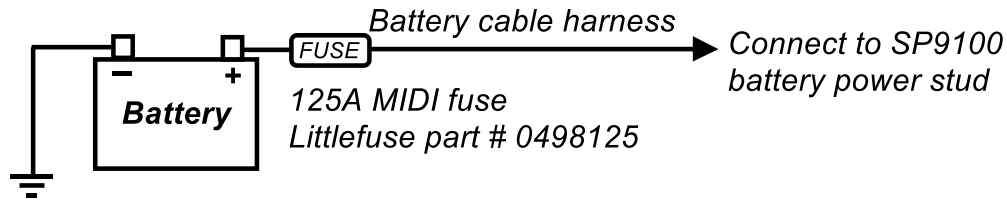

## 5. Communications Cable

5.1 The Communications Cable is a 10.5', specialty cable, with shielding and a soldered drain wire, which connects the Switch Panel and Power Module. The smaller, white, connector plugs into the wires off the back of the switch panel, and the larger, black, connector plugs into the Power Module. This cable is typically fed through the engine firewall.

- Note: Do not alter the length of the cable. If you need a longer/shorter cable, please visit our website.
- To feed the Communications Cable through a tight space, it may be necessary to remove the black 4-pin connector. Do not unpin the white connector. It is not serviceable.
  - Note: Before un-pinning, note the original color pin-out prior to removing the connector.
  - Step 1: Insert a small screwdriver (max. width of 3.00mm (.118")) into the pry point of the Terminal Position Assurance (TPA).
  - Step 2: Using the housing as a pivot point, gently pry out the TPA until it reaches pre-lock position.
    - Note: The TPA should never be fully removed from the connector housing.
  - Step 3: Using the 1.50mm (.059") MOLEX service tool #63813-1500, or a paper clip (end must be rounded), insert the tip into the terminal service hole, adjacent to the terminal to be serviced. Push straight down gently and apply pressure to release-locking finger. This motion will release the locking finger, "picking" is not required. A click can be felt once fully engaged.
  - Step 4: Gently pull the wire to be released.
    - Note: If the terminal resists, the service tool may not be fully engaged.
    - Note: Do not insert the service tool at an angle, this may cause damage to the terminal.
  - Step 5: When re-installing the terminal, make sure the TPA is in the released position, and the orientation of the terminal is correct. Once the terminal is seated, push down on the TPA, applying even force.



Step 2

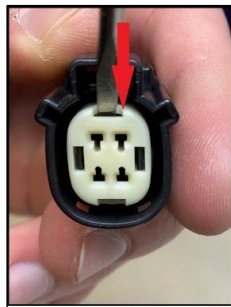

Step 2

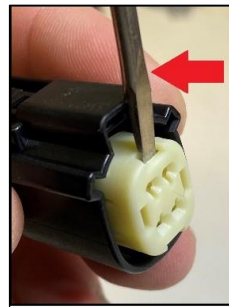

Step 2

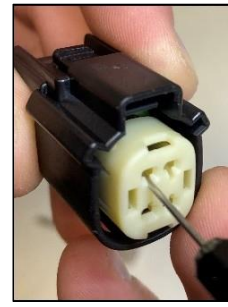

Step 3



Step 4

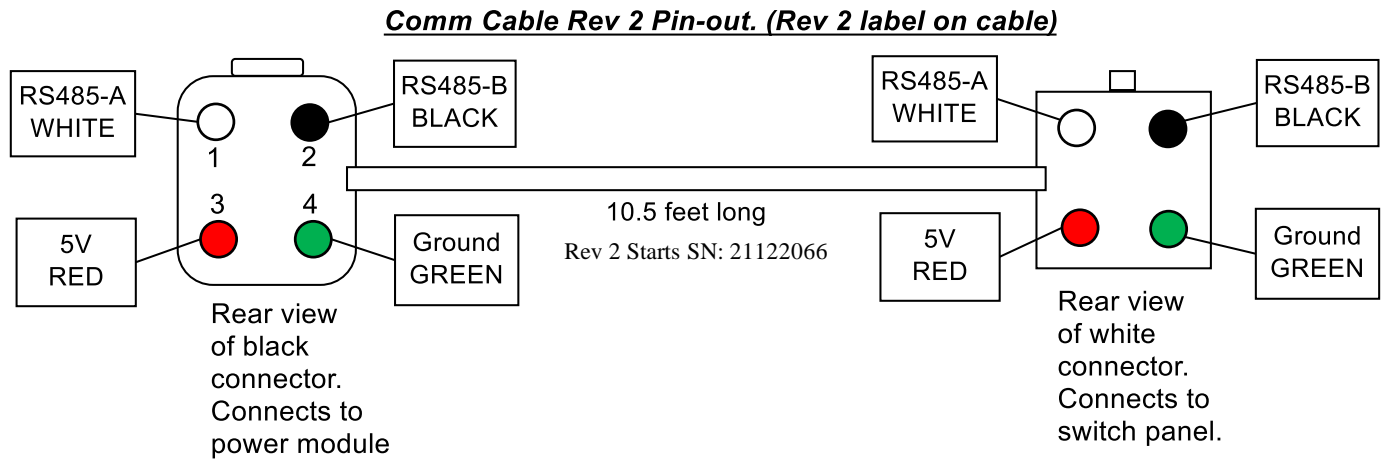

## **PROGRAMMING**

### **6. Bluetooth Connection**

#### **6.1 Downloading the App**

- Apple Devices
  - Launch the App Store → Search for Switch-Pros → Click “Get.”
  - Once installed, locate the app on your home screen and click on it to open.
  - You must allow ALL Bluetooth, location, etc. permissions.
- Android Devices
  - Launch the Google Play Store → Search for Switch-Pros → Click “Install.”
  - Once installed, locate the app on your home screen and click on it to open.
  - You must allow ALL Bluetooth, location, etc. permissions.

#### **6.2 How to Connect**

- Be sure you are within +/- 50 ft of your Switch Panel.
- Click “Scan for Local Devices” → A white box will pop up, and the name of Switch-Pros panel(s) in range will appear.
  - If the app does not show your panel and you are within range, follow the steps below.
    - Apple Devices: Close the Switch-Pros app and launch your settings app. In your settings, find “Privacy & Security” → “Bluetooth” → be sure Switch-Pros is enabled.
    - Android Devices: Close the Switch-Pros app and launch your settings app. In your settings, find “Apps” → find “Switch-Pros” → click “Permissions” → be sure Bluetooth and Location are both allowed.
  - If the blue light, in the top, center, of your Switch Panel, is illuminated prior to connecting, you will need to unplug the Communications Cable for 30 seconds. After plugging it back in, the blue light will go out, and the device will appear when you Scan for Local Devices again.
- Click on the name of your Switch Panel to connect and the screen will then show a box with a loading icon.
  - If you are connecting for the first time, your panel will be named SWCHPRO.
- Once a virtual panel appears, you have successfully connected.
- Note: If there is a Bluetooth connection established, the Switch Panel in the vehicle will also be functional, regardless of Battery/Ignition Switch programming. This means that if you remove the keys from the vehicle, AND your Bluetooth device is still connected, ALL switches on the Switch Panel will function, even if they are programmed as Ignition input. If the Bluetooth device is disconnected, then the switches on the Switch Panel that are programmed for Ignition input will only function with the ignition on.
- Note: If Bluetooth connection is lost, or app is closed while battery input outputs are on, outputs will remain ON.
- Note: While in the Settings screens, switches are non-functional.

## 7. SP9100 App Functions

### 7.1 Configure Switches

- ON/OFF – Momentary
  - This function will program the switch to be latching or momentary.
  - Default is On/Off
- Battery/Ignition
  - This function determines which system input is needed to turn the switch on from the panel.
  - Default is Ignition
    - Note: When connected via Bluetooth, all switches will be operational, whether programmed as Battery or Ignition.
- Flash
  - This function will program the switch to flash at a similar rate to a turn signal.
  - Default is Flash Off
    - Note: When Flash On is selected, the switch must be double-pressed for the flash function to activate. If 1 Touch Flash is selected, the switch will activate this pattern when it is pressed once, from the off position.
- Strobe
  - This function will program the switch to strobe, or perform a series of very fast flashes.
  - Bursting Strobe is a series of fast flashes, then off, then fast flashes, then off, etc.
  - Default is Off
    - Note: When Constant Strobe or Burst Strobe are selected, the switch must be double-pressed for the strobe or bursting strobe function to activate. If Constant 1 Touch Strobe or Bust 1 Touch Strobe is selected, the switch will activate this pattern when it is pressed once, from the off position.
- Low Voltage Disconnect
  - This function will turn outputs off when the battery voltage drops below 11.0, 11.5, or 12.0 volts (selectable thresholds) for 1 minute.
  - Default is LVD On; 11.0V
    - Note: Up to six selectable outputs can remain on.
    - Note: This function's purpose is to keep the battery from draining, in the event that one or more outputs are left on.
- Memory
  - This function remembers the last switch status before the ignition was turned off.
  - Default is Memory Off
    - Note: If a switch was on when ignition was shut off, that switch will turn back on when the ignition is turned back on.
- Master Switch
  - This function will program any switch to be a master switch to turn on other switches.
  - Default is Master Control Off
    - Note: Master Control On Only will turn the selected switches on, but requires switches to be turned off individually. Master Control On and Off will turn the selected group of switches on and off with the press of the Master switch.

### 7.2 LED Backlighting

- To change the backlighting color, either select one of the 4 preset colors, or click on the colored square to launch the RGB color picker.
- To adjust the brightness of the LED indicators, when the Lights/T2 Trigger activates, use the top slider.
- To adjust the brightness of the Switch Panel backlighting, when Lights/T2 Trigger activates, use the bottom slider.



### 7.3 Set Switch Name & Icon

- Enter text or select the icon to appear in the App's switch buttons.

### 7.4 Set Panel Name

- This is the name of your SP9100, which will appear in the list of nearby devices, when "Scan for Local Devices" is pressed in the App.
  - Default is "SWCHPRO"
  - Note: There is a limit of 8 characters.

### 7.5 Set Password

- When a password is set, the App will require that password to be input, prior to allowing connection to your panel via Bluetooth.
  - Note: If you forget the password, please contact Technical Support, with your Serial Number on hand, for instructions on how to reset it. [TechSupport@Switch-Pros.com](mailto:TechSupport@Switch-Pros.com) or 949-581-2991

### 7.6 Enable Output Dimming

- This allows for dimming of outputs, such as lighting, heated seats, etc.
  - Note: All switch outputs are dimmable. The dimming function must be enabled for each output, in the App.
  - Note: When the dimming function is enabled, the switch will still function normally if pressed on/off. The dimming is actuated by pressing and holding the switch on for 1.5 seconds. The switch LED indicator will start to flicker rapidly, indicating the active dimming, and the output will dim from 100% to 50% to 10% repeatedly. The switch LED indicator flicker rate will also decrease, indicating the level of dimming. When the desired dimmed level is achieved, releasing the switch will lock in the dimming level. The level is not stored and resets each time the switch is powered off.
  - Note: If the PRESET for the switch is turned ON (in the dimming menu), the output will dim to the last used dim level, when the switch is turned on, with one push of the switch.

### 7.7 Set Auto Sleep Settings

- The Switch Panel will enter sleep mode after the preset time, drawing a minimal amount of current (3mA).
  - Default is 480 minutes, or 8 hours.
  - Note: The Sleep Mode timer is programmed in minutes, with a range of 0 to 65,500 minutes.
  - Note: The normal current draw of the system is around 35mA. After 5 minutes of inactivity, the system will go Idle and the current draw will drop to 5.5mA (with all switches off and no Ignition, Lights or Trigger inputs). In Idle Mode, the Switch Panel can still be accessed via Bluetooth.
  - Note: In Sleep Mode, Bluetooth and the Switch Panel are disabled.
  - Note: The system will "wake up" when the Ignition, White Lights/T2, or Pink Trigger 1 Wires sense voltage, or if any switch on the Switch Panel is pressed.
  - Note: For the system to enter Sleep Mode the system must be completely Idle, Ignition, lights and trigger inputs must be off, all outputs must be off, and no Bluetooth connection can be present.

### 7.8 External Trigger Setup

- This function programs the Pink Trigger 1 and/or the White Lights/T2 to activate up to 4 switches each. See Section 4.2 for wiring recommendations.
  - Trigger 1 Mode
    - Default is Normal
    - Note: High Beam Lockout selection requires the Pink Trigger 1 Wire to sense voltage to have certain switches operational.
      - Note: This function was added to satisfy international traffic laws but is not required in the United States.
  - External Trigger Setup
    - Trigger 1: Select Enable

- Active High or Active Low: The Trigger Input can be triggered by an Active High (12V) or Active Low (Ground) signal.
- Output 1 – 4: Select the switches that are to be turned on with the Trigger.
- Lights/Trigger 2: This Trigger is to remain Disabled and Active High, if being used to dim the Switch Panel backlighting
  - To convert Lights/T2 to a Trigger, select Enable, choose between Active High or Active Low, and select the switches that are to be turned on with the Trigger.

#### 7.9 Temperature Units

- This setting allows for the Power Module temperature, displayed in the App, to be in degrees Celsius or degrees Fahrenheit.

#### 7.10 Setup Connected Units

- This setting is used to setup Slave Switch Panels.
  - Note: This screen is only used for special order systems. Call Tech Support with questions.

#### 7.11 Power-Up Switch Status

- This function programs any switch to turn on immediately, when power is connected to the Power Module, or the Light Blue Ignition wire senses 12V, depending on the switch's input setting.
  - Note: The switch can still be turned on and off on the Switch Panel.

#### 7.12 Off Delay Switch Settings

- This function programs a switch to have a timed delay, before shutting off.
  - Note: This feature only works with Ignition input switches. The off-delay timer begins when the Light Blue Ignition Wire ceases sensing 12V.
  - Note: The Off-Delay is programmed in seconds, with a max delay of 18,000 seconds, or 5 hours.
  - Note: This feature is typically used for fans, oil coolers or lighting that must remain on for a set period of time, after the ignition is turned off.

#### 7.13 Output Overcurrent Values

- This function allows for adjustment of the amperage each circuit will trip at.
- Switches 1-4 have a maximum current limit of 20 Amps, and switches 5- 8 have a maximum current limit of 35 Amps.
- Overcurrent values can be adjusted in 5A increments.
- Since battery voltage and amperage draw are inversely related, when battery voltage drops, amperage draw will increase. Do not reduce current limits too low, or the circuits will trip unnecessarily.
  - Note: Any current draw, over the current limit, for longer than 0.5 seconds, will trip the circuit. When a circuit is tripped, the LED indicator, above the switch, will flash 3 times. Only the affected switch output will turn off and reset.

#### 7.14 SPDT and SP3T Switch Configuration

- This function creates a relationship between 2 or 3 switches, disallowing any of them from being on at the same time. If Output 1 is on, and Output 2 is turned on, Output 1 will automatically be shut off.
  - Note: This function is commonly used for lights with a high and low beam that cannot be on at the same time, or other accessories with multiple modes.

#### 7.15 Restore Settings to Default Values

- This function removes all programming from the system and restores it to default values.
  - Note: This does not remove the Bluetooth password.

#### 7.16 Dual System Connection

- Enabling this function allows Bluetooth connection to 2 Switch-Pros systems at once.
  - Note: Once enabled, exit out of Settings and click "Panel 2", in the virtual panel, to connect to another unit.

### 7.17 Summary of Programmed Functions

- This screen provides a complete summary of the functions programmed into the system.

## SPECIAL FUNCTIONS CONTROLLED THROUGH THE SWITCH PANEL

**8. The following functions can be turned on and off through the Switch Panel. The referenced Programming Switch is in the center of the Switch Panel, behind the Switch-Pro logo. The Programming LED, in the top, center, of the Switch Panel, will flash 3 times for confirmation of the action performed.**

### 8.1 Bluetooth

- Off: Programming Switch and Switch 1
- On: Programming Switch and Switch 2

### 8.2 Sleep Mode

- Off: Programming Switch and Switch 3
- On: Programming Switch and Switch 3
- Sleep Mode Instantly On: Programming Switch and Switch 5
  - Note: This will disable Bluetooth. Bluetooth will need to be enabled again (See Section 8.1).
  - Note: For the system to enter Sleep Mode, the Light Blue Ignition Wire, Lights/T2 Wire, and Pink Trigger 2 Wire inputs must be off, all switches must be off, and no Bluetooth connection may be present.

### 8.3 Pink Trigger 1

- On and Off: Programming Switch and Switch 7
  - Note: Trigger 1 must be enabled in the App before being able to be turned on and off through the Switch Panel.

### 8.4 White Lights/T2

- On and Off: Programming Switch and Switch 8
  - Note: Trigger 2 must be enabled in the App before being able to be turned on and off through the Switch Panel.

### 8.5 Restore to Default Values

- Disconnect the Communications Cable, either at the back of the Switch Panel or at the Power Module, then hold down Switch 7 while plugging it back in. Continue holding Switch 7 until the Switch Panel finishes running through the backlighting colors Red, Green, Blue and White.
  - Note: This does not remove the Bluetooth password.
  - Note: This function is in systems starting with SN: 21120547.

### 8.6 Slave Panel to Master Panel

- Disconnect the Communications Cable, either at the back of the Switch Panel or at the Power Module, then hold down Switch 8 while plugging it back in. Continue holding Switch 8 until the Switch Panel finishes running through the backlighting colors Red, Green, Blue and White.
  - Note: This is only to be performed if a Master Switch Panel is turned into a Slave Switch Panel by accident.
  - Note: This function is in systems starting with SN: 21120547.

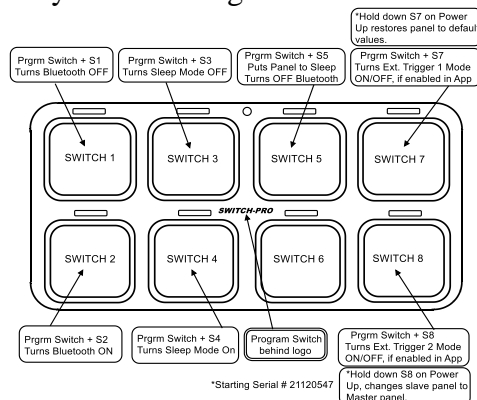

NAME/LEGEND	WIRE COLOR	SWITCH ACCESSORY	TOTAL AMPS/LIMIT	FUNCTION/PROGRAMING
SW1:	BROWN			
SW2:	RED			
SW3:	ORANGE			
SW4:	YELLOW			
SW5:	GREEN			
SW6:	DARK BLUE			
SW7:	PURPLE			
SW8:	GRAY			

**Trigger Wires**

**Trigger 1:**  Active High Or  Active Low  
(Triggers above 5v) (Triggers below 0.5V)

Source: \_\_\_\_\_  
Switches: \_\_\_\_\_

**Lights or Trigger 2:**  Active High Or  Active Low  
(Triggers above 5v) (Triggers below 0.5V)

If the lights wire is being used to dim the panel's backlighting it must be set to active high and disabled.  
Source: \_\_\_\_\_  
Switches: \_\_\_\_\_

**High Beam Lock out:**  
Switches: \_\_\_\_\_

**Low Voltage Disconnect**  
Set Voltage: \_\_\_\_\_  
Switch Exceptions: \_\_\_\_\_

**Master Switch**  
Master SW: \_\_\_\_\_  
Switches Controlled: \_\_\_\_\_  
Function/Programming: \_\_\_\_\_

**Power Up Switch Status**  
Switches: \_\_\_\_\_

Bluetooth Password: \_\_\_\_\_

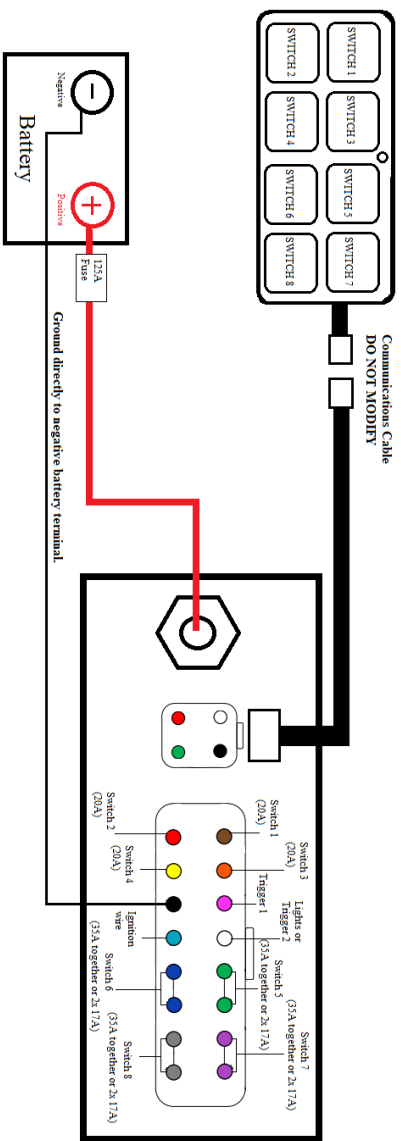

SP-9100 Wiring Diagram

# SWITCH-PROS

Phone # 949.581.2991  
 www.switch-pros.com  
 sales@switch-pros.com